

Service  
Service  
**Service**

# Service Manual



© Copyright 2004 Philips Consumer Electronics B.V. Eindhoven, The Netherlands  
All rights reserved. No part of this publication may be reproduced, stored in a retrieval system or transmitted, in any form or by any means, electronic, mechanical, photocopying, or otherwise without the prior permission of Philips.

Published by LO-MF AV System

Printed in The Netherlands

Subject to modification



3139 785 30853

**Version 1.3**



# PHILIPS

# CONTENTS

1.	Specifications .....	1-1
2.	Product Validation Strategies and Process	
2.1	System Block Diagram .....	2-1
2.3	Front Panel .....	2-2
2.4	Rear Panel .....	2-2
3.	Fault Finding Tree & Trouble shooting .....	3-1
4.	Disassembly Instructions	
5.1	Disassemble the Top Cover .....	3-1
5.1	Disassemble the Drive .....	3-1
5.1	Disassemble the HDD .....	3-1
5.1	Disassemble the M/B .....	3-1
5.1	Disassemble the Power Module .....	3-1
5.1	Disassemble the Tuner .....	3-1
5.1	Jumper Setting .....	3-1
5.	Firmware Update .....	5-1
6.	Exploded View & Spare parts list	
Exploded view for /37/97 .....		6-1
Exploded view for /00/02/04/05/69/75 .....		6-2
DVD Test disc & Service parts list .....		6-3
7.	Revision List .....	7-1

# 1. Specifications

## SPECIFICATIONS

### DISC TYPES SUPPORTED (Read Only):

DVD-R/RW, DVD+R/RW, CD-R/RW

### CONTENT FORMAT SUPPORTED :

- 1) DVD-Video
- 2) DVD+VR (DVD+VR format is compatible with DVD-Video in most case)
- 3) Video CD
- 4) Super VCD
- 5) Audio CD
- 6) MP3  
Maximum number of files recognizable : 9999 files  
Compression rate : between 32 kbps and 320 kbps
- 7) JPEG  
Maximum number of pictures recognizable : 9999 files
- 8) BMP  
Maximum number of pictures recognizable : 9999 files

### RECORDABLE MEDIA SUPPORTED:

- 1) DVD+R (DVD+VR Mode)
- 2) DVD+RW (DVD+VR Mode)
- 3) Built-in 80GB HDD (DVD+VR mode)

### VIDEO RECORDING MODE

Mode	DVD	HDD
M1	1hr	17hr
M2	2hrs	34hr
M2x	2.5hrs	42hr
M3	3hrs	51hr
M4	4hrs	68hr
M6	6hrs	102hr

### VIDEO RECORDING FORMAT

MPEG2: DVD+VR (M1/M2/M2x/M3/M4 mode)  
MPEG1: DVD+VR (M6 mode)

### VIDEO PERFORMANCE

DA Converter 10-bit / 54MHz  
Composite Output 1 Vpp 75 Ohm  
Components Output Y : 1 Vpp 75 Ohm  
P<sub>b</sub> : 0.7 Vpp 75 Ohm  
P<sub>r</sub> : 0.7 Vpp 75 Ohm

SCART Output CVBS/S-Video/RGB

### AUDIO RECORDING FORMAT

DVD+VR (M1/M2/M2x/M3/M4/M6 mode): Dolby Digital 2-channel

### AUDIO FORMAT SUPPORTED - Playback

Analog output 2channel  
Digital output coaxial/optical  
Format supported LPCM/Dolby Digital/MPEG

### AUDIO PERFORMANCE

DA Converter 24-bit/96KHZ  
AD Converter 24-bit/96KHZ  
Signal-Noise (1kHz) ≥90dB  
Dynamic Range (1kHz) ≥80dB  
Cannel Separation (1kHz) ≥110dB  
Total Harmonic Distortion (1kHz) ≤70dB

### TUNER

TV format PAL

### CONNECTIONS

#### FRONT PANEL

Video Input RCA Connector (yellow) x1  
Audio L/R Input RCA Connector (white/red) x1  
IEEE 1394 Input Mini jack x1

#### REAR PANEL

Video Output RCA Connector (yellow) x1  
Audio L/R Output RCA Connector (white/red) x1  
SCART Output 21 pin, CVBS/RGB/S-Video  
SCART Input 21 pin, CVBS/RGB  
Component / Y, P<sub>b</sub>, P<sub>r</sub> (Green/Blue/Red) x1  
Progressive Scan Output  
Digital Audio Output Coaxial x1  
Optical x1

### GENERAL

Power Supply AC 200 ~ 240V 50Hz  
Power Consumption Approx. 50 W  
Operating Temperature +5° C to +40° C (+36° F to +104° F)  
Operating Humidity 5% to 80% RH  
Dimensions(W/H/D): 430 x 66 x 316 mm  
Net Weight: Approx. 4.8 kg

### Notes:

The specifications and design of this product are subject to change without notice.

## 2. Product Validation Strategies and Process

### 2.1. System Block Diagram

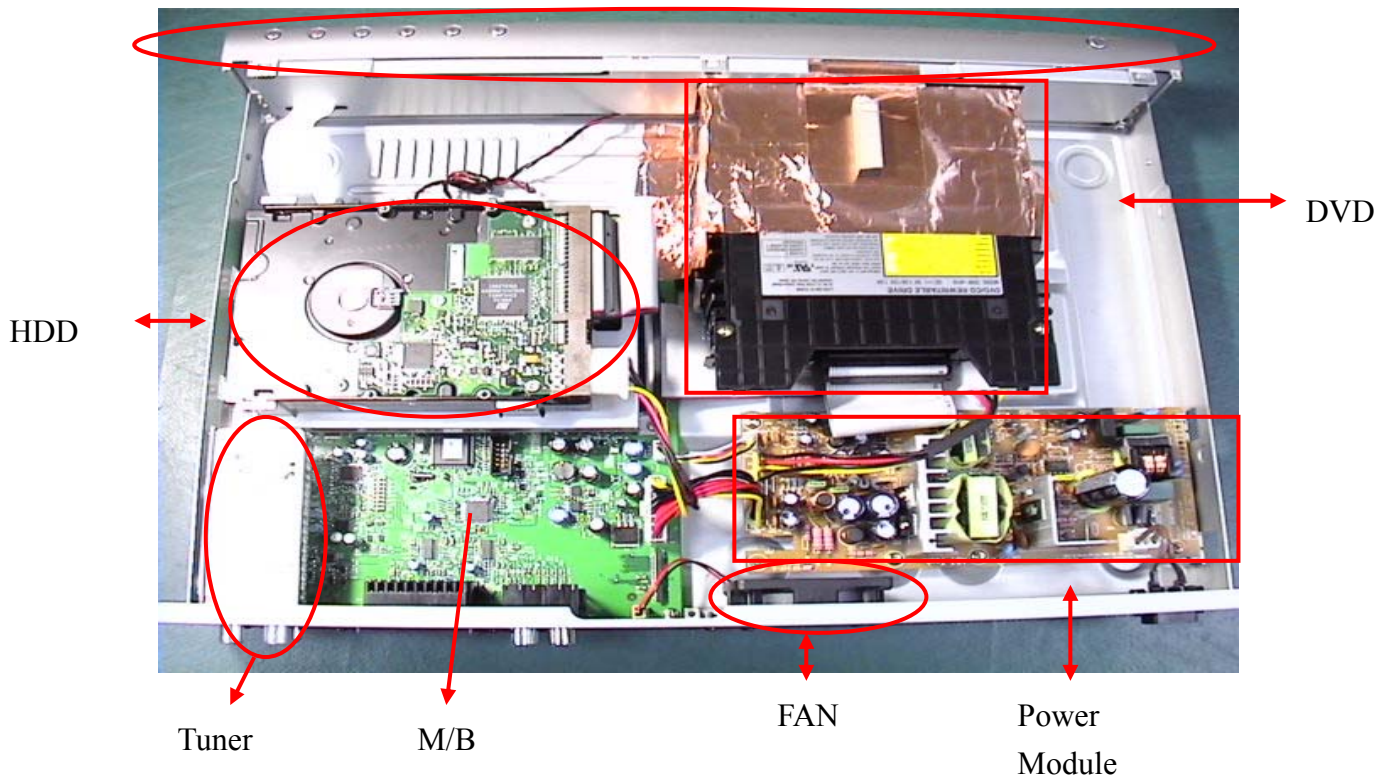
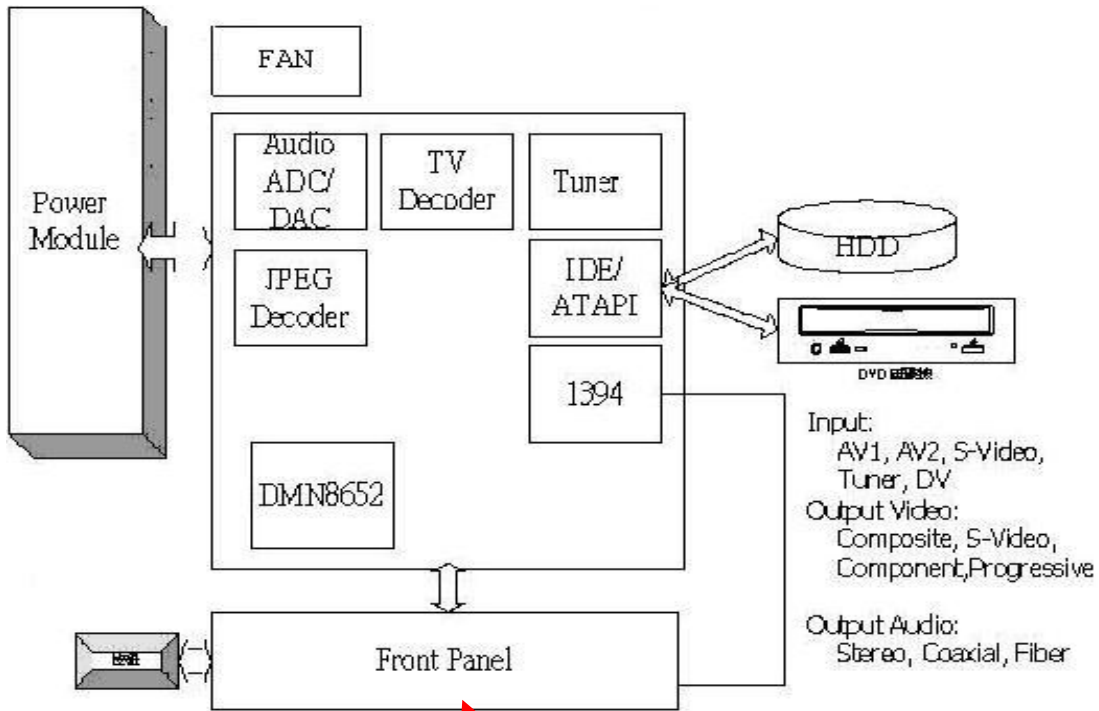

## 2.2. Front Panel

### Front panel connections

(for reference only)

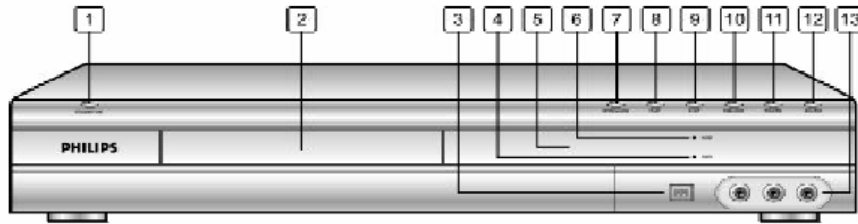

#### Names of parts and controls

- |  |   |
|--|---|
| <ol style="list-style-type: none"> <li>1) <b>POWER ON/OFF Button</b><br/>Turns the recorder on and off.</li> <li>2) <b>DISC TRAY</b><br/>Holds discs securely during recording or playback</li> <li>3) <b>DV-LINK (IEEE-1394) Jack</b><br/>Connects digital video camcorders to this DVD Recorder.</li> <li>4) <b>DVD Indicator</b><br/>Lights up when DVD is set as the target device.</li> <li>5) <b>DISPLAY Panel</b><br/>Operation indicators are displayed here.</li> <li>6) <b>HDD Indicator</b><br/>Lights up when HDD is set as the target device</li> </ol> | <ol style="list-style-type: none"> <li>7) <b>OPEN/CLOSE Button</b><br/>Opens or closes the disk tray.</li> <li>8) <b>PLAY Button</b><br/>Plays a disk.</li> <li>9) <b>STOP Button</b><br/>Stops playing or recording a disk.</li> <li>10) <b>HDD/DVD Button</b><br/>Press to switch between HDD and DVD.</li> <li>11) <b>RECORD Button</b><br/>Starts recording.</li> <li>12) <b>SOURCE Button</b><br/>Select equipment connected to the line inputs.</li> <li>13) <b>Front AV (VIDEO/AUDIO L/R) Jacks</b><br/>Connects the input of external equipment.</li> </ol> |
|--|---|

## 2.3. Rear Panel

### Rear panel connections

(for reference only)

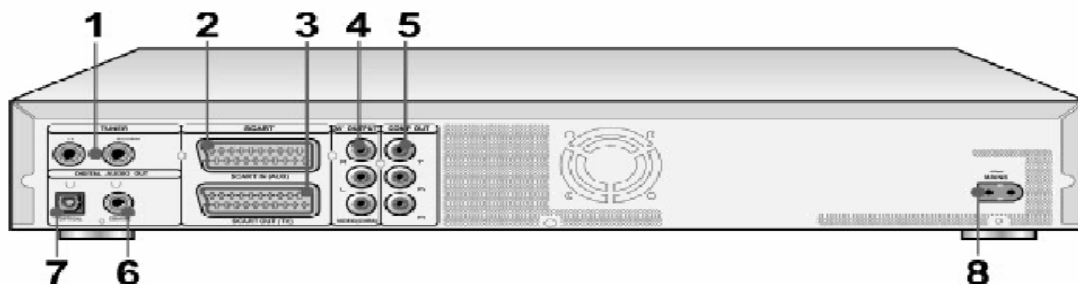

#### Names of parts

- |  |   |
|--|---|
| <ol style="list-style-type: none"> <li>1) <b>TUNER (TV/ANTENNA) Jacks</b><br/>Connects TV/ANTENNA for signal output/input.<br/><b>Note:</b> DVD signals don't go through here. Make proper connections before use.</li> <li>2) <b>SCART IN (AUX) Jack</b><br/>Composite/RGB signal input.</li> <li>3) <b>SCART OUT (TV) Jack</b><br/>Composite/RGB/S-Video signal output.</li> <li>4) <b>LINE OUT (R/L/VIDEO (CVBS)) Jacks</b><br/>Composite signal output.</li> </ol> | <ol style="list-style-type: none"> <li>5) <b>LINE OUT (Y/Pb/Pr) Jack</b><br/>Component signal output.</li> <li>6) <b>DIGITAL OUT (COAXIAL) Jack</b><br/>Connect to an amplifier or a receiver having a digital output jack.</li> <li>7) <b>DIGITAL OUT (OPTICAL) Jack</b><br/>Connect to an amplifier or a receiver for a digital output jack.</li> <li>8) <b>Mains Terminal</b><br/>Connect the power cord.</li> </ol> |
|--|---|

### 3. Fault Finding Tree

Start condition:

1. Plug the power cord
2. Power on

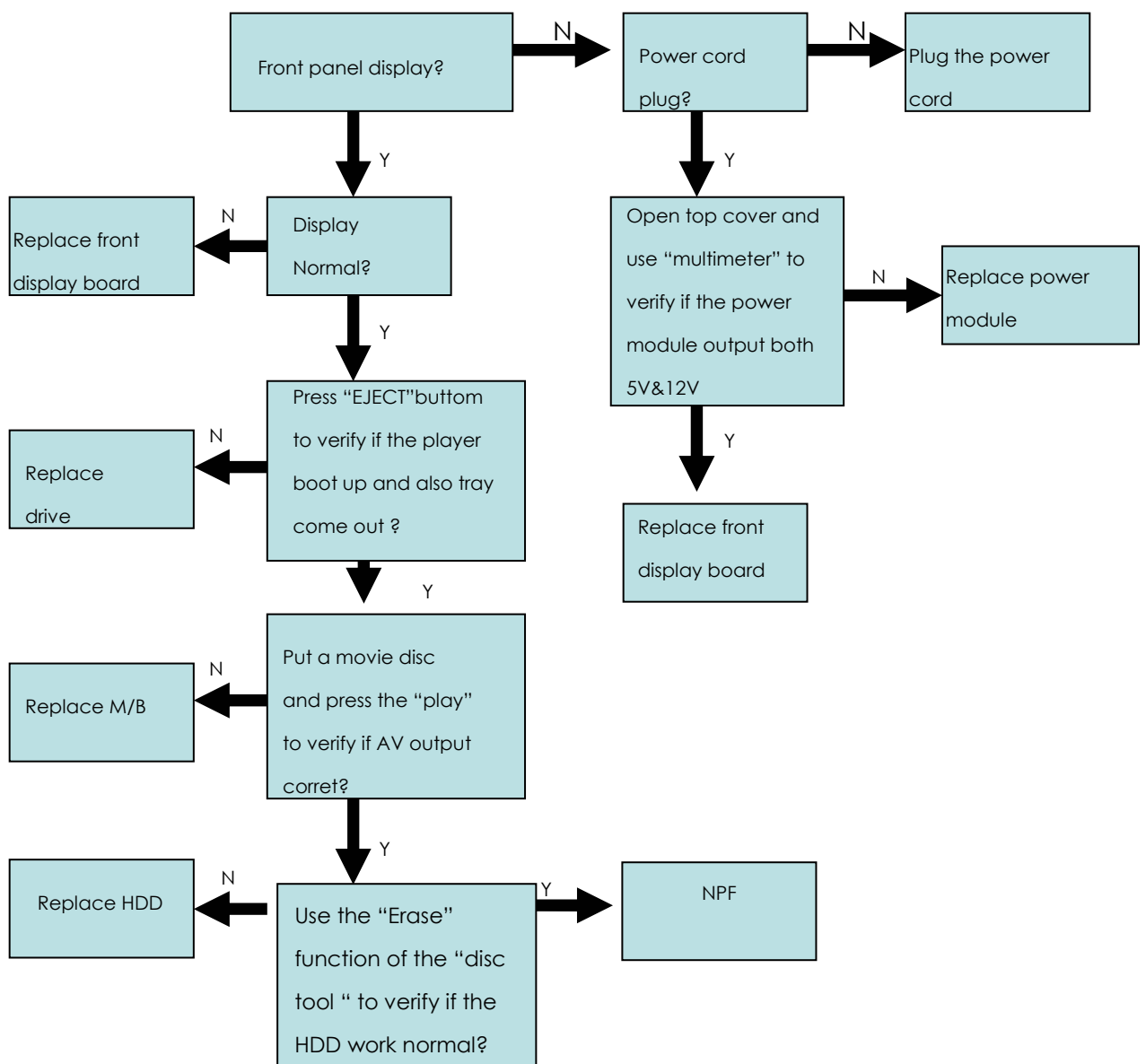

**Start condition:**

1. Plug the power cord
2. Power on

**Recording**

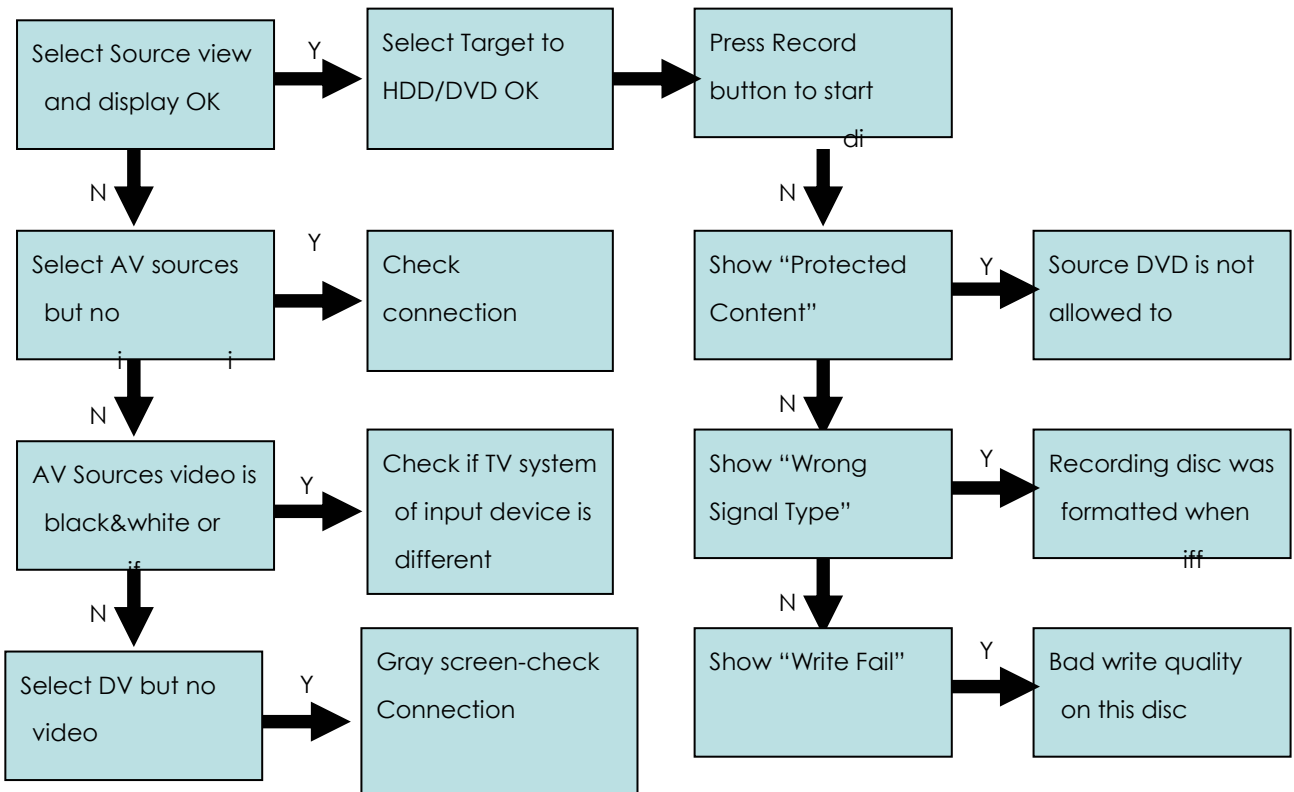

**Start condition:**

1. Plug the power cord
2. Power on

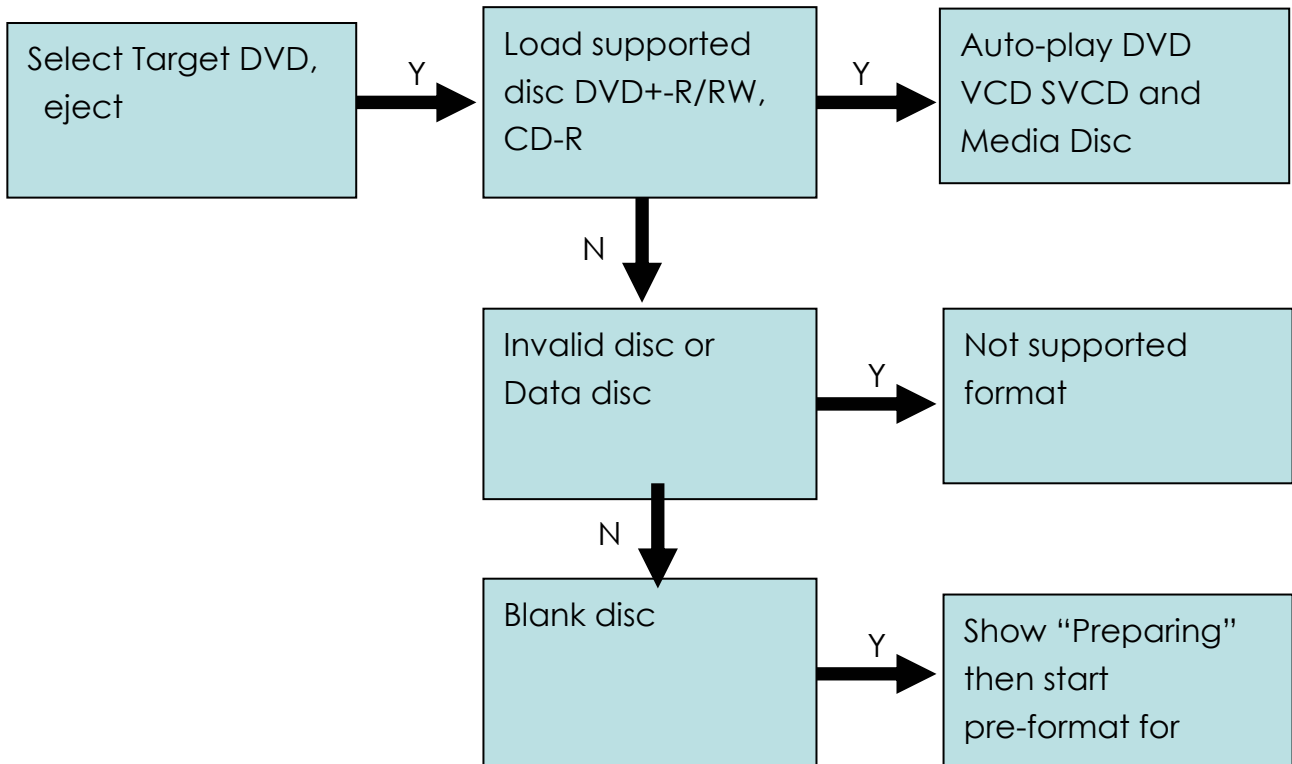
**DVD Playback**



**Tuner :**  
**Select the source into TV mode first**

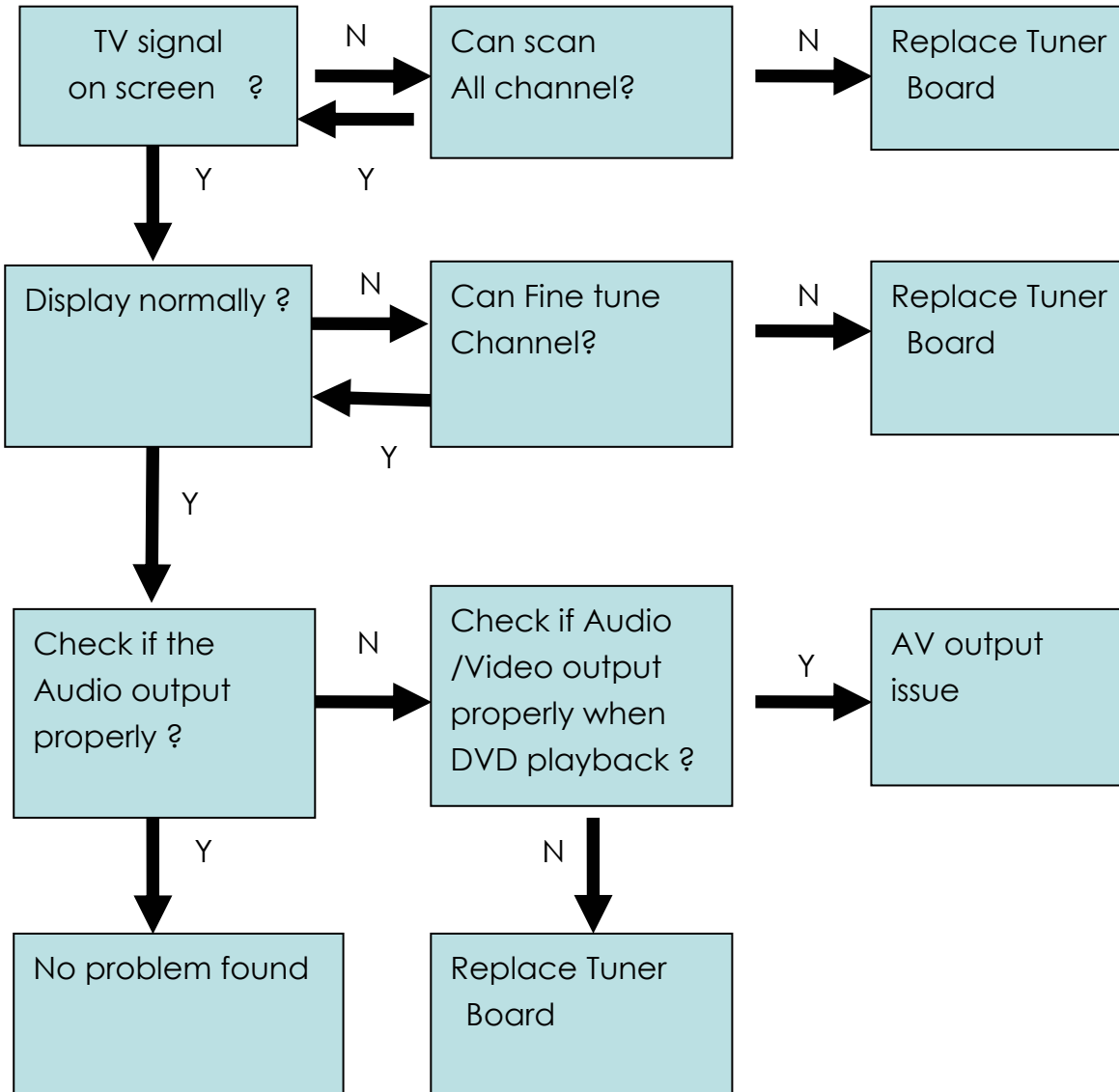

**Reference of defect symptoms for repair**

- After power cord plug in ,LED no display , but AV output normal after power on -> replace display board
- After power on , the color of the screen isn't correct -> replace M/B
- After power on , the fan doesn't work -> replace power module / Fan
- Can't eject or show "No Disc" -> replace drive
- Can't auto format any brand new disc -> replace drive
- Recording will auto stop or hang -> replace M/B & drive
- Playback will have mosaic -> replace M/B
- Can't format HDD -> replace HDD
- Can't record with HDD -> replace HDD
- No Audio or audio output abnormal -> replace M/B
- Optical / Coaxial no output when the setting is set as DTS output -> replace M/B
- Can't update F/W through drive -> replace drive
- Can't detect DV when plug in/out with a DV -> replace display board
- AV1 input mode doesn't output video / audio when connected to a normal external AV source -> replace display board
- AV2 ( Scart) / S-Video input mode doesn't output video / audio when connected to a normal external AV source -> replace M/B

Module Fail / Problem	Remedy / Symptom
HDD	<ul style="list-style-type: none"> <li>■ Run Disc Tool/Format/HDD show "Fail", this could be a bad HDD</li> </ul>
	<ul style="list-style-type: none"> <li>■ Run Disc Tool/Defragment show "Fail", this could be a bad HDD</li> </ul>
	<ul style="list-style-type: none"> <li>■ Format no problem but show "Write Fail" during recording , this could be a bad HDD</li> </ul>
DVD Drive	<ul style="list-style-type: none"> <li>■ Load any disc always show "No disc", this could be a bad DVD drive</li> </ul>
	<ul style="list-style-type: none"> <li>■ Load some kind of discs always show "No disc". For example load DVD no problem, but load CD-R show "No disc", this could be a bad DVD drive</li> </ul>
	<ul style="list-style-type: none"> <li>■ Cannot open tray. User can try to power off the recorder, and then press "Eject" to boot again. If still can not open, this could be a bad DVD drive. If tray open successfully and there is a disc inside, it's the disc cause drive busy. Try another disc, if user can tray in/out no problem, the drive should be ok.</li> </ul>
DVD/CD disc	<ul style="list-style-type: none"> <li>■ Run Disc Tool/Format/DVD show "Fail". This could be a bad disc or not compatible with our DVD drive.</li> </ul>
	<ul style="list-style-type: none"> <li>■ Format no problem but show "Write Fail" then stop during recording. Press "Record" again may be user can continue record, but part of the audio/video on this disc may not smooth. This could be a bad disc or not compatible with our DVD drive.</li> </ul>
	<ul style="list-style-type: none"> <li>■ Take long time to load disc then show "Invalid Disc". The disc could be a bad disc or unsupported format</li> </ul>
Power	<ul style="list-style-type: none"> <li>■ Connect power cord, but LED display show nothing, Press remote or button on the panel still nothing happened. This could be a power board problem</li> </ul>
	<ul style="list-style-type: none"> <li>■ Replace power cord if find any available. We use a common power cord user may able to find the same one on his other electronic products</li> </ul>
Remote	<ul style="list-style-type: none"> <li>■ Press buttons on remote but nothing happened, system can still power on by buttons on panel. OSD doesn't show system receive any key. This could be a bad remote or ran out of battery.</li> </ul>
	<ul style="list-style-type: none"> <li>■ Or it could be a bad receiver on the front panel</li> </ul>
Front Panel	<ul style="list-style-type: none"> <li>■ System can power on and work by remote no problem, but press buttons on panel does not work. This could be a bad front panel</li> </ul>

Module Fail / Problem	Remedy / Symptom
Video Output	<ul style="list-style-type: none"> <li>■ Can not see any display or color abnormal, video distortion. Make sure cables connected correctly. Try another output like S-video, AV, Component, and Scart.</li> </ul>
	<ul style="list-style-type: none"> <li>■ Run SETUP to select available video output</li> </ul>
Audio Output	<ul style="list-style-type: none"> <li>■ Can not hear any sound output through speakers of TV or amplifier. Make sure cables connected correctly. Try another output like AV, optical, coaxial</li> </ul>
	<ul style="list-style-type: none"> <li>■ Playing DVD movie, when select DTS out on DVD audio menu no audio output. User needs to run SETUP/Audio/DTS to set DTS ON</li> </ul>
TV Tuner	<ul style="list-style-type: none"> <li>■ Run SETUP, Tuner setting correctly, but after scan TV channel can not select correct TV programs. Run SETUP/ Tuner/TV signal, select Antenna or Cable then run "Channel Scan" again, don't use "Auto". "Auto" will re-arrange channel table and remove channel numbers not available.</li> </ul>
	<ul style="list-style-type: none"> <li>■ User selects TV signal/country correctly, after scan still cannot select channel, this could be a bad TV tuner.</li> </ul>
External source	<ul style="list-style-type: none"> <li>■ Connect external source like AV, S-video, Scart, DV-link (1394) can not see the video input. Make sure cables connected correctly. If these signals connect to other AV products no problem. This could be a bad connector</li> </ul>
	<ul style="list-style-type: none"> <li>■ For DV, user need to know the DV is NTSC/PAL, and the playing DV tape is NTSC/PAL. They must be the same TV type as the recorder to make it works properly.</li> </ul>
Can not Real-time Record	<ul style="list-style-type: none"> <li>■ Show "Protected Content", it's Copy-Protected and not allowed to copy</li> </ul>
	<ul style="list-style-type: none"> <li>■ Show "Wrong Signal Type" when record to disc. The disc was formatted by different TV system (NTSC/PAL). For DVD±RW, user can reformat this disc (contents on this disc will be erased). For DVD±R, user can only change another disc</li> </ul>
	<ul style="list-style-type: none"> <li>■ Press "Record" shows key blocked, will not start recording. Maybe user select wrong Target device. Press Target to choose HDD/DVD</li> </ul>
	<ul style="list-style-type: none"> <li>■ Empty DVD-R/RW, CD-R/RW user needs to format by Disc Tool before recording</li> </ul>
Can not Timer Record	<ul style="list-style-type: none"> <li>■ Open "Timer" record again, there is a message shows why it failed, please move the cursor to column status and it will show the reason it fails</li> </ul>
	<ul style="list-style-type: none"> <li>■ Selected recording "Target" is unable to record when Timer starting time</li> </ul>

Module Fail / Problem	Remedy / Symptom
Cannot play a disc	<ul style="list-style-type: none"> <li>■ If it's not "Invalid disc", could be unsupported format/contents in the disc</li> </ul>
Copying	<ul style="list-style-type: none"> <li>■ Show "Fail" when copying files/discs, it could be unsupported format</li> </ul>
	<ul style="list-style-type: none"> <li>■ Show "Fail" when copying recorded DVD+VR title, it could be out of disc space</li> </ul>
System Upgrade	<ul style="list-style-type: none"> <li>■ Follow the firmware update procedure in the chapter "Firmware update".</li> </ul>
	<ul style="list-style-type: none"> <li>■ If upgrade failed (power failure during upgrade or ...), maybe every time system power on will show "Put Cd In". Users must load the upgrade disc again to recover.</li> </ul>

### **Trouble Shooting Guide (DVDR520H)**

#### **1 Just "HELLO"**

- 1.1 First recognize what kind of "Hello" it is. You have got two types; one with Power on and one after Power on, when the DVD starts up.
- 1.2 If the unit takes a long time to complete the power-on process, check IDE cable (or 4 IDE connector: connecting between Loader & HDD) whether assembly / connecting properly or not.
- 1.3 To check the connector between main board and power module had been assembled / connected properly. ( Fan on rear panel should rotate continuously ) if there is no power supplying to main board ( Yellow: +12V <-> Red: +5V measured with universal voltage meter ), replace / change another new Power Module.
- 1.4 Check the FFC (18 pin) cable between main board and display board had been assembled connected well.
- 1.5 If after checking above still Just "Hello" do the following:
  - Replace/change another new Main Board; if still not work,
  - Replace/change another new DVD writer ( Loader ) if still not work,.
  - Replace/change another new HDD;

## 2 No Display On LED Module

- 2.1** Put a paper in between the M/B and the barebone, for preventing the M/B shortcut with ground and Re-test again.
- 2.2** To check the connector between main board and power module had been assembled / connected properly. (Fan on rear panel should rotate continuously) if there  
 Is no power supplying to main board ( Yellow: +12V <-> Red: +5V measured with universal voltage meter ), replace / change another new Power Module.
- 2.3** Check the FFC (18 pin) cable between main board and display board had been assembled connected well.

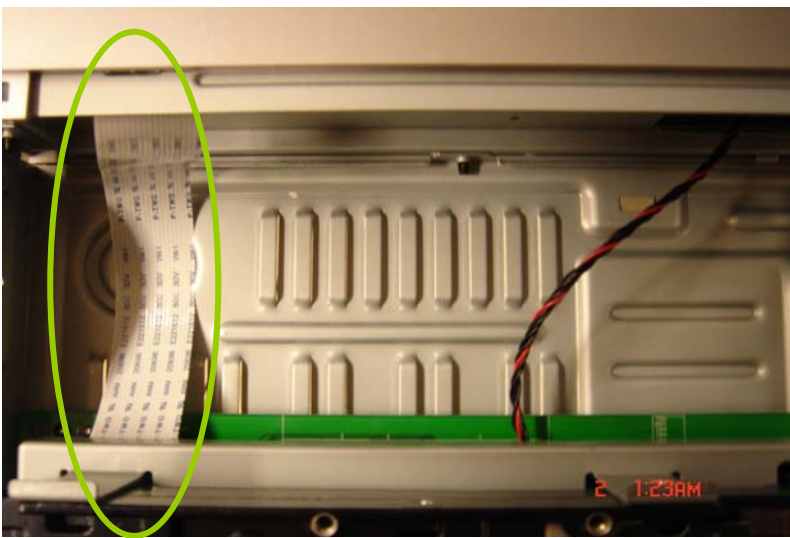

- 2.4** Short the JP8 (on the main board) with jumper, and then, plug with power cord to check if the text on the LED module had been lighted on. (Test mode of Display Board had been activated). In case the answer is negative, replace / change another new Display Board.
- 2.5** Replace / change another new Main Board. (There should be something wrong with IC component: AT89S52, DMN-8652 .....)

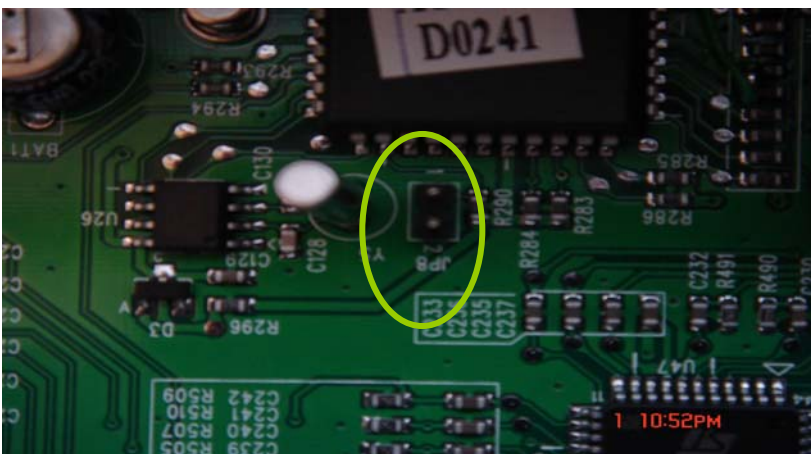

### 3 Loader (DVD writer) Failure

#### 3.1 Tray can't open

**3.1.1** Disassemble the Loader, and press the eject button on the Loader (with power

supply connected : 4 pin connector) to check whether the tray can open or not. Re-assembly DVD writer (Loader), pay attention to assembly issue (Plastic layer of Loader stuck to front) and the position of IDE cable (40 pin; flat cable).

**3.1.2** Check the FFC (18 pin) cable between main board and display board had been assembled / connected well.

#### 3.2 Not ready ( Loader can't identify / recognize the disc )

**3.2.1** In this case update the loader firmware to latest version. Please select several kind of DVD and CD discs including 8x and 4x DVD+R/RW, and test if loader can both playback and record on the disc.

1. If yes, then this maybe a media compatibilities issue. The firmware update can solve it.
2. If can not playback or record at all, change another new loader.
3. If just can't record on some disc, wait for a new firmware release or change another new loader.

#### 3.3 Copy/Recording failure or Mosaic appeared

1. Check if the recorded disc is dirty or scratch. If yes, try another disc to check again.
2. If no, update loader to latest and check it again.
3. If it still can't work, Replace/change another new loader and check it again.
4. If it still can't work, Replace/change another new Main-board and check it again.

### 4 Update FirmWare

#### 4.1 Tray can't open

**4.1.1** Re-assembly DVD writer (Loader), pay attention to assembly issue ( Plastic layer of Loader stuck to front ) and the position of IDE cable ( 40 pin; flat cable ).

**4.1.2** Check the FFC (18 pin) cable between main board and display board had been assembled / connected well.

**4.1.3** Disassemble the Loader, and press the eject key on the Loader (with power supply connected : 4 pin connector) to check whether the tray can open or not. If the answer is negative, Replace / change another

new Loader.

**4.1.4** After that, tray still can't open. Replace / change another new Main Board.

#### 4.2 Put in CD

**4.2.1** Put the update \disc on the tray and pressing open/close key to make the tray close, system would update firmware automatically. This may take a while, wait for the loader to read the firmware update. When "error" on panel replace Mainboard

**4.2.2** In case the tray still eject in a few seconds later, Replace/change another new Main Board.

#### 4.3 especially case (Firmware updating fail )

**4.3.1** Open the tray and put in the firmware disc, tray in and wait the disc ready after A-up (AP upgrade) ,start to upgrade the loader, if finished it will show "done" in LCD panel.

**4.3.2** In case d-up (loader upgrade) to 99% then show "error ",

1. Please wait tray-out and remove the update disc ( **please note don't turn off the power immediately , please wait about 70 seconds** ) .
2. Press the power key to power off , then restart the power on again .The set will show " put in CD " then put in update disc and update again..
3. If still fail , change the loader.

### 5 TV (Tuner Function) Failure

**5.1** Make sure that the Tuner Board had been assembled on Main Board at the right (pin) position and that it is clicked in. Also check the capacitor 470uF on the Tuner Board must be shorted and is still intact .Look if the pins of the tuner are still straight and are placed in the right place

**5.2** If the answer of former step is positive and all is assembled correctly, Replace another new Tuner Board.

**5.3** In case the tuner (TV) function still had not worked, Replace/change another new Main Board.

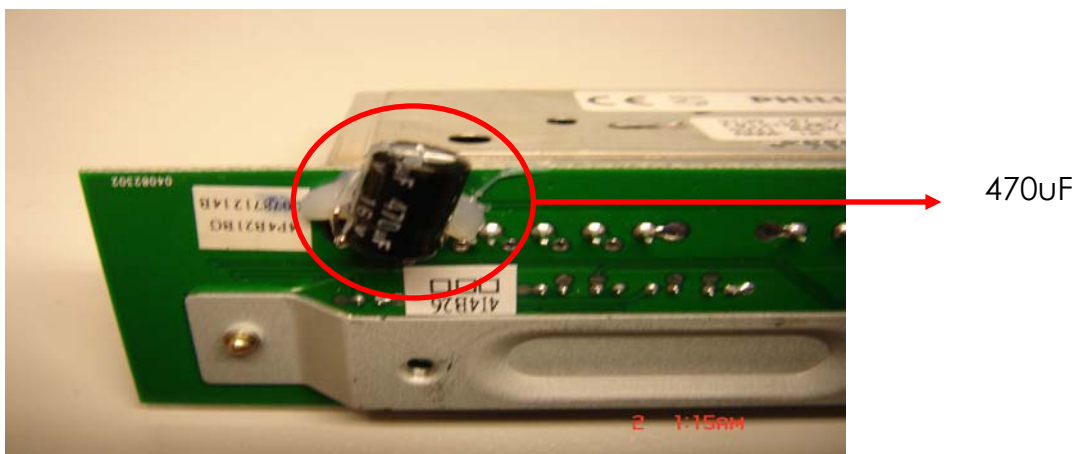



**6 Erasing****( HDD ) Failure**

**6.1** First confirm recognizes HDD ). See

that it is a HDD Failure by using the Timer ( If it the HDD ) and Erase Function ( Format the Picture below

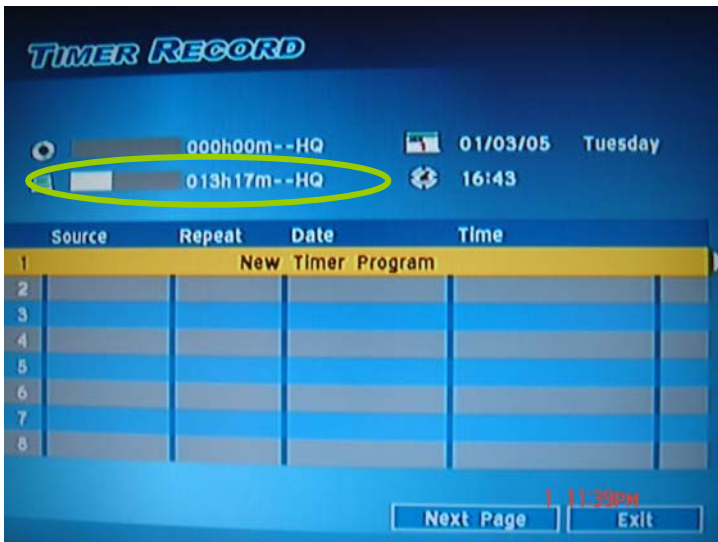

- 6.2** Check if the voltage of connector which connected to HDD is correct or not.( Yellow: +12V <-> Red: +5V).If no, change the power module. See picture below.
- 6.3** If failed, check IDE cable/connector (40 pin) of HDD device whether assembly / connecting properly or not.
- 6.4** If not, connect it well and try again
- 6.5** If yes, remove the HDD from the set and connect it to a PC to check if the PC can recognize it or not. ([Seagate screen test](#))!
- 6.6** If the PC can recognize it ,the format it on the PC and put it back to the set, then excute erase function again.
- 6.7** If not, replace / change another new HDD.
- 6.8** If still Failed try replacing the Main Board.

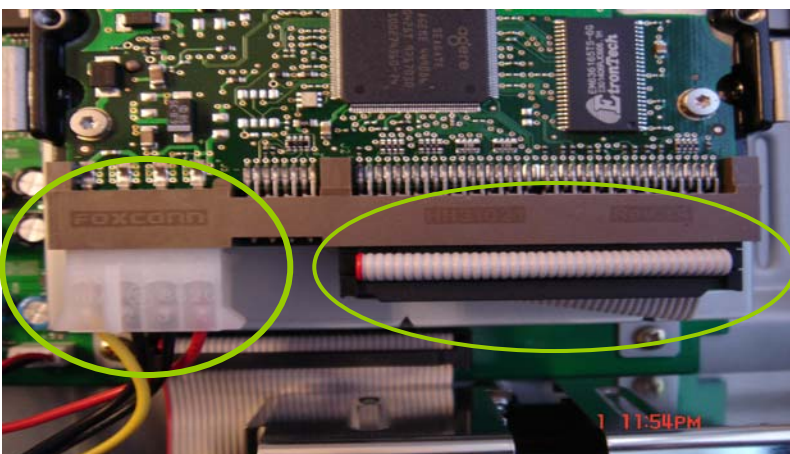

## 7 DV Test Failures:

7.1 To check JP1 (5 pin) connector on Main Board had been assembled / connected properly.

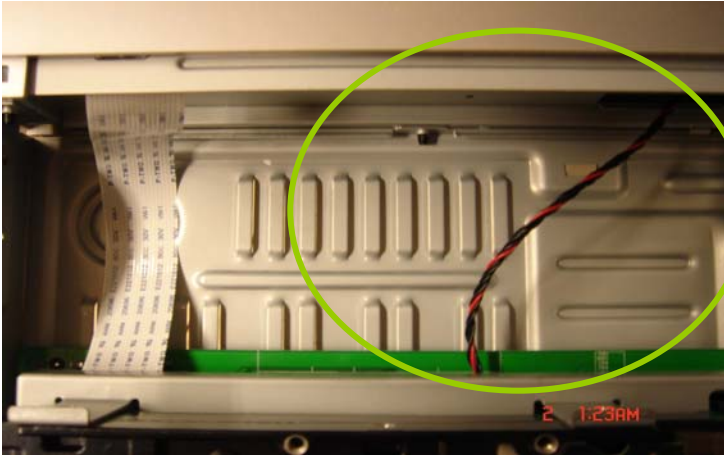

7.2 To check the place/position of Display Board where the 5 pin connector had been shorted or not, if the answer is yes, Replace/change another Display Board.

7.3 Otherwise, Replace/change another new Main Board.

## 8 Output picture abnormal

### 8.1 Black screen (LED display CH2)

8.1.1 Make sure that the Tuner Board had been assembled on Main Board at the right (pin) position and to check if the capacitor on the Tuner Board is open or shorted.

8.1.2 If yes , replace another new Tuner Board.

8.1.3 Otherwise, Replace/change another new Main Board.

### 8.2 No picture output ( while Playback )

8.2.1 In case no scart out, please make sure the RCA out is ok or not.

1.If yes and picture abnormal, update firmware to latest and check it again via scart

2.Otherwise , replace another new Main Board.

### 8.3 No picture output ( while from AV1 input )

8.3.1 To check the connector between main board and display board had been assembled / connected properly

8.3.2 source from AV1 (front) : exchange new front panel to make sure workable or not

8.3.3 if still failed, replace another new Main Board

## 4. Disassembly introductions

### 4.1 Disassemble the TOP-COVER:

#### Step 1:

Loosening the fixed screws of the TOP-COVER totally 6 screws, 4 on the rear panel and 1 on the left side and the other on the right side of the TOP-COVER, (as PICTURE 1 & 2 & 3)

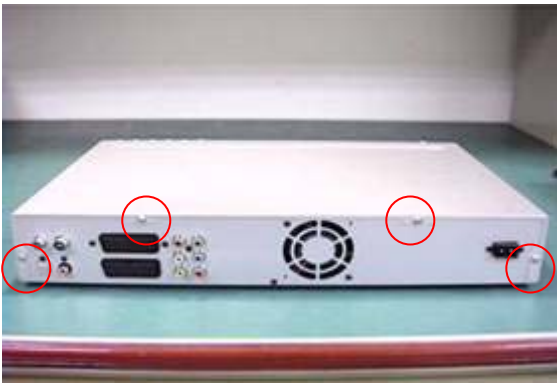

(PICTURE 1)



(PICTURE 2)

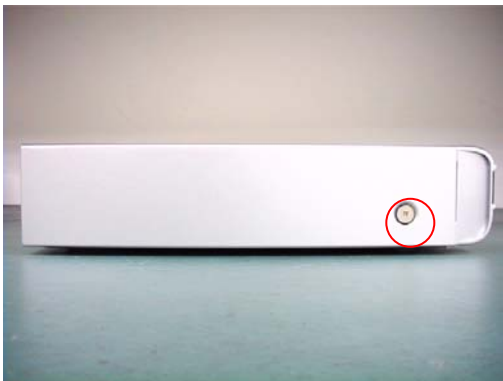

(PICTURE 3)

#### Step 2:

Pull back to remove the TOP-COVER and let the cover-top lie on horizontally smooth desk to prevent being out-of-shape place upside down (as PICTURE 4)



(PICTURE 4)

## 4.2 Disassemble the Drive:

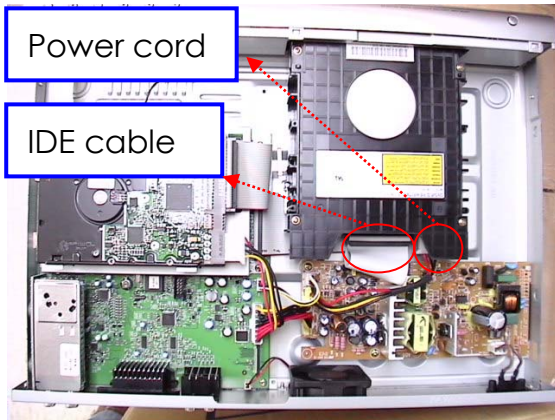

(PICTURE 5)

SCREWS



(PICTURE 6)

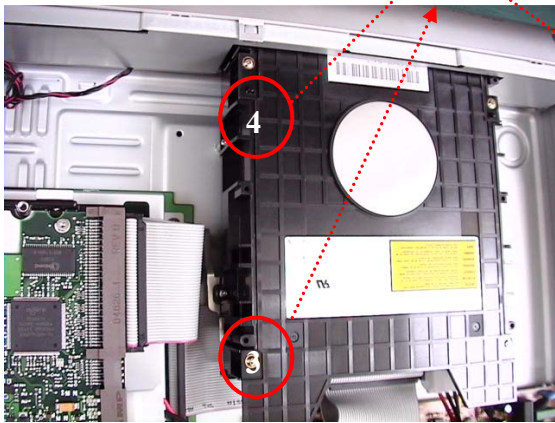

(PICTURE 7)

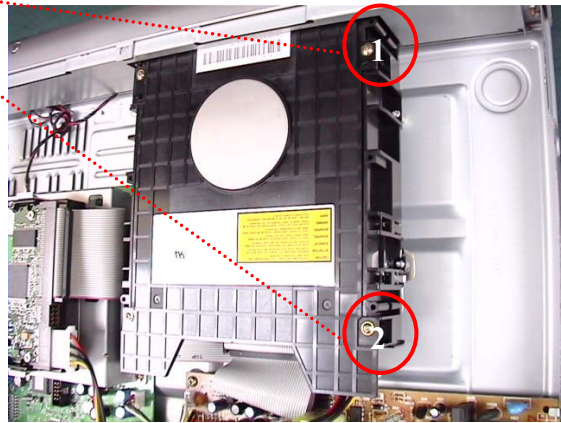

(PICTURE 8)

**Step 1:** Tray out → pull out the door and lift up to disassemble the tray door (as PICTURE 6)

**Step 2:** Tray in → Power off → unplug the power cord

**Step 3:** Disassembly the top cover

**Step 4:** Unplug the power cord and IDE cable (as PICTURE 5)

**Step 5:** Remove the four fixed screws of the drive (screw 1~4 as PICTURE 7 &8)

**Step 6:** Remove the Drive

**PS:** If the tray is jammed can't be out on step 1, please unplug the power cord first ,then follow the step 3-5 ,and then lift up the drive on the rear side to separate



the tray door and tray.

4-3

### 4.3 Disassemble HDD:

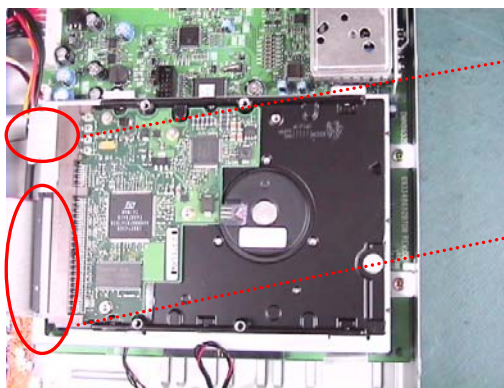

(PICTURE 9)

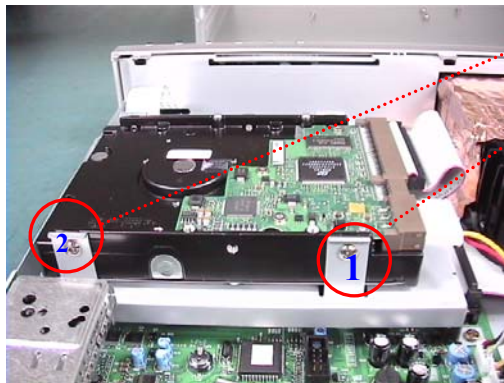

(PICTURE 10)

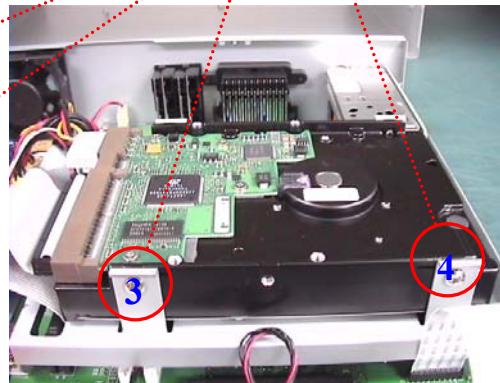

(PICTURE 11)



(PICTURE 12)

**Step 1:** Disassembly the top cover

**Step 2:** Unplug the power cord and IDE cable (as **PICTURE 9**)

**Step 3:** Loosen the screws off the chassis (1~4 in **PICTURE 10 & 11**)

**Step 4:** Take out the HDD (as **PICTURE 12**)

## 4.4 Disassemble the M/B:

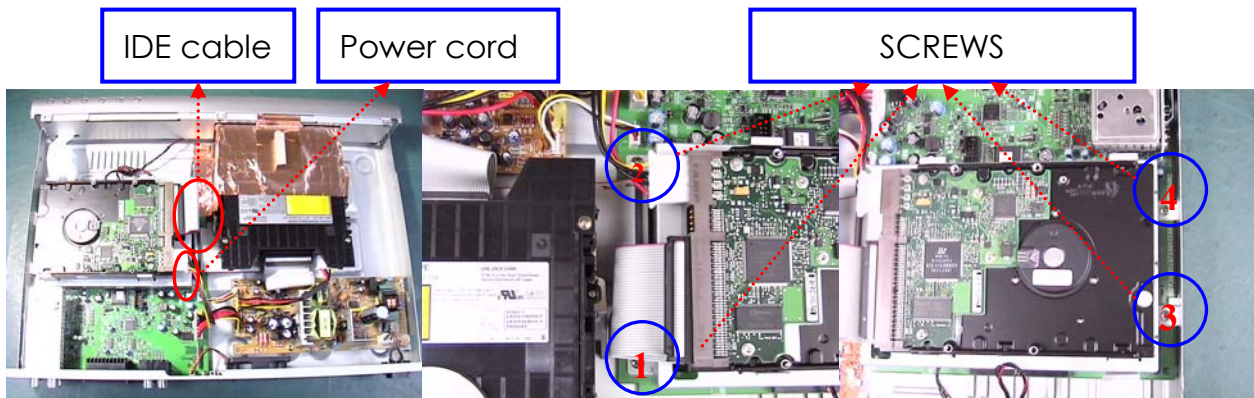

(PICTURE 13)

(PICTURE 14)

(PICTURE 15)

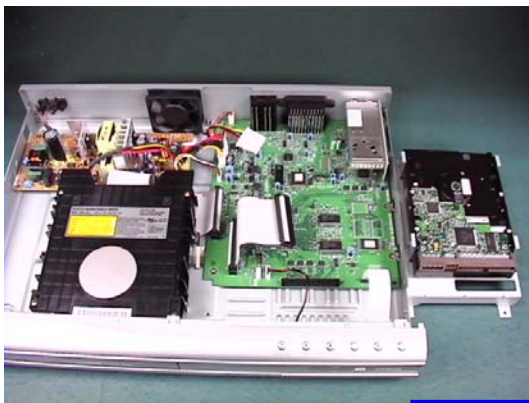

(PICTURE 16)

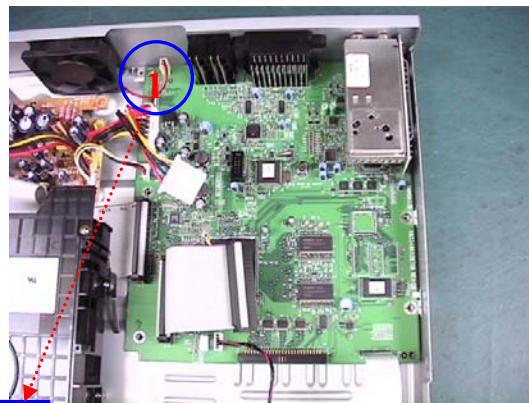

(PICTURE 17)

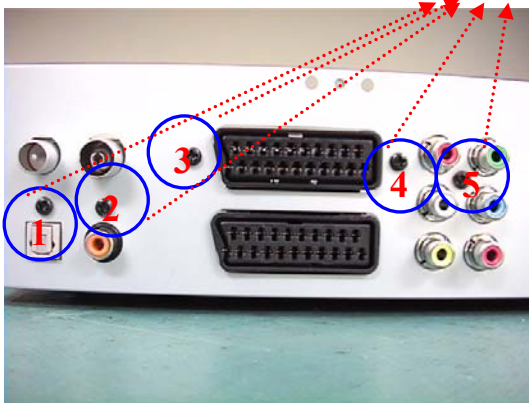

(PICTURE 18)

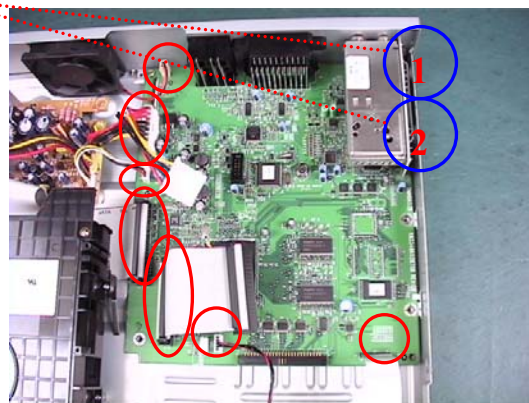

(PICTURE 19)

**Step 1:** Unplug the power cord and IDE cable of the HDD module (as PICTURE 13)

**Step 2:** Remove the HDD module from the M/B first, unfix the 4 screws of the HDD module (as PICTURE 14, 15, 16)

**Step 3:** Unfix the screw of the M/B and remove all the cable (7 cables) connected to M/B (as PICTURE 17 & 19)

**Step 4:** Loosen the 5 screws off the rear panel (as PICTURE 18)

**Note:** Tuner can be removed and reused if isn't broken when M/B is disassembled

## 4.5 Disassemble the Power Module

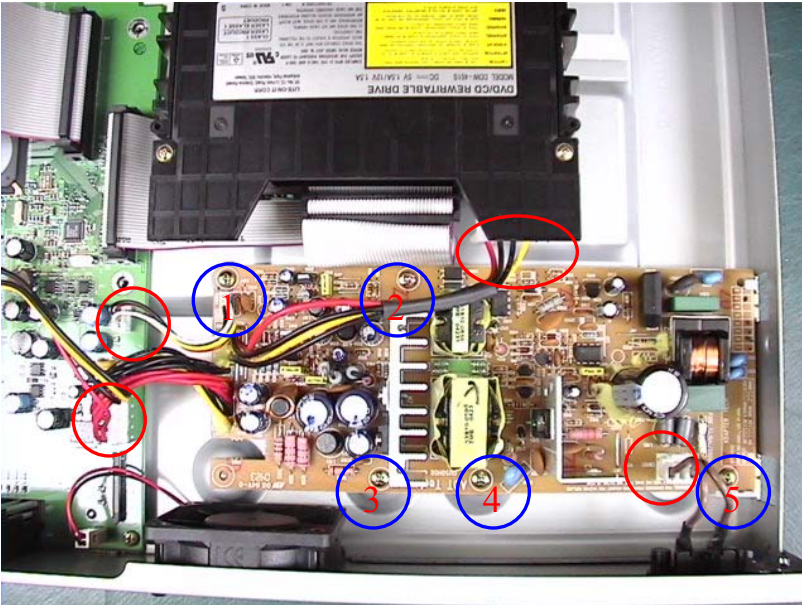

(PICTURE 20)

- Step 1:** Disconnect all the cables connected to other module (total 4 cables as red circle in PICTURE 20)
- Step 2:** Loosen the screws off the chassis (1~5 in PICTURE 20)
- Step 3:** Take out the power module



## 4.6 Disassemble Tuner board



(picture 21)



SCREW

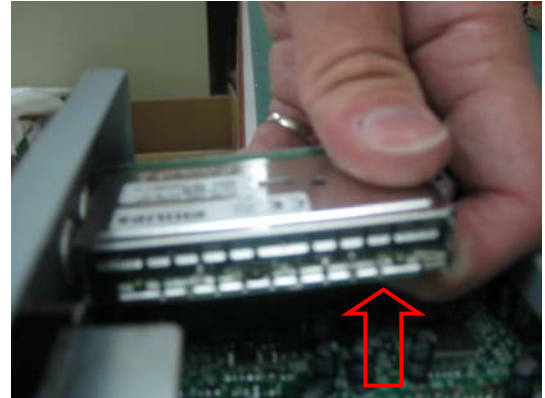

(picture 22)



(picture 24 )

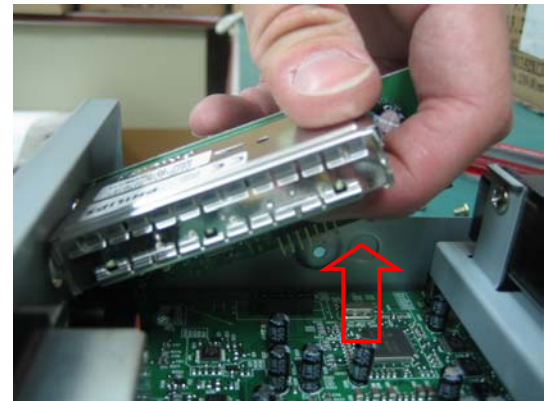

(picture 23)

**Step 1:** Unplug the power cord before replace the Tuner board

**Step 2:** Loosen the screws off the chassis (2in PICTURE 21)

**Step 3:** Take out the tuner board follow the disassemble direction as picture 22.23.24.

**Note :** When assemble Tuner Board please follow the sequence from picture 24 -> 21



## 4.7 JUMPER Settings

### HDD

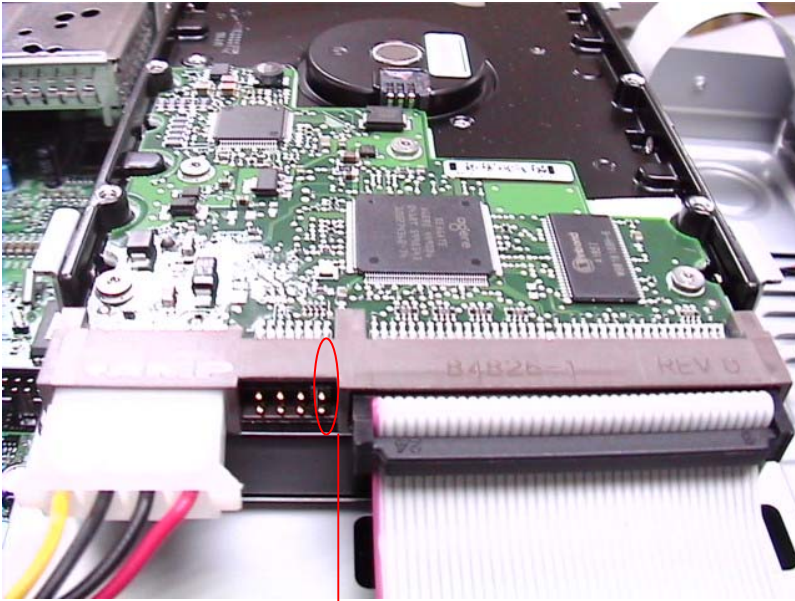

JUMPER

### ODD



JUMPER

## 5. Firmware Update

1. Burn the firmware on a single-session ISO disc.
2. Power on the system.



3. After system is ready, load the firmware update disc.



4. System will start detect the firmware image and if the image is detected, LED will show "F-UP xxxx", where "xxxx" is the build number.



5. If system detects the image file, a confirm dialog will display on the screen. Follow the instruction to complete the update process.

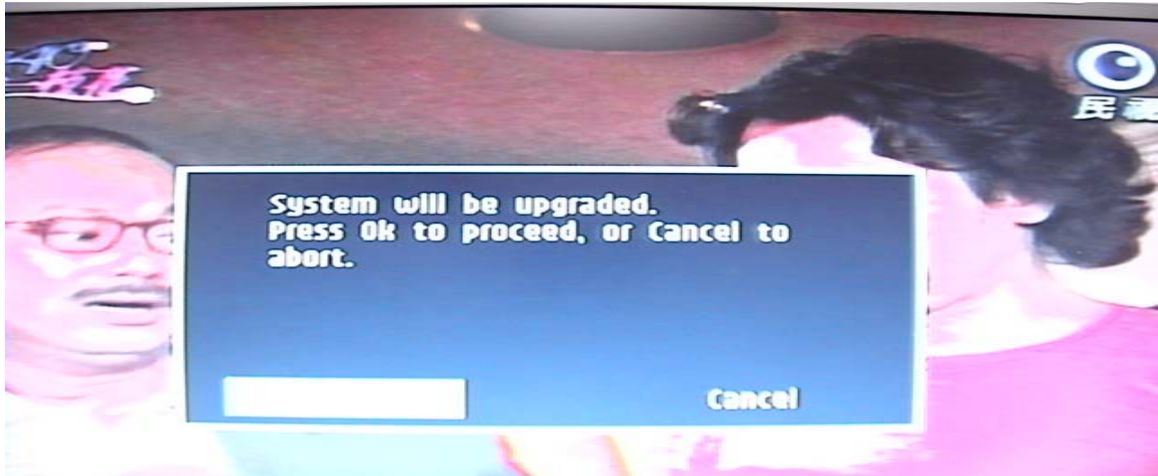

6. If system firmware is updated without error, LED will show "done". Else "error" will show.



7. Reboot the system.

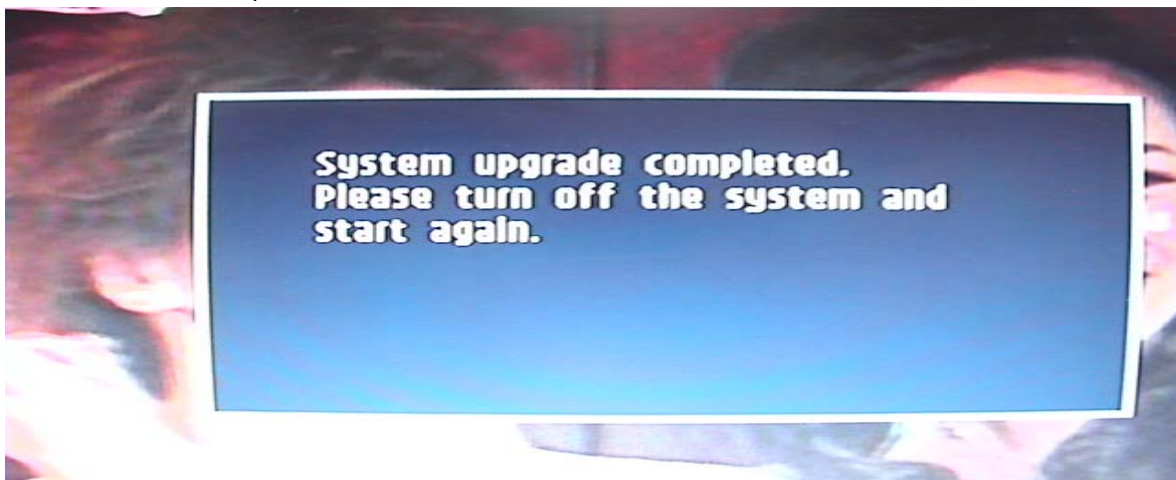

# 6. Exploded View & Spare List

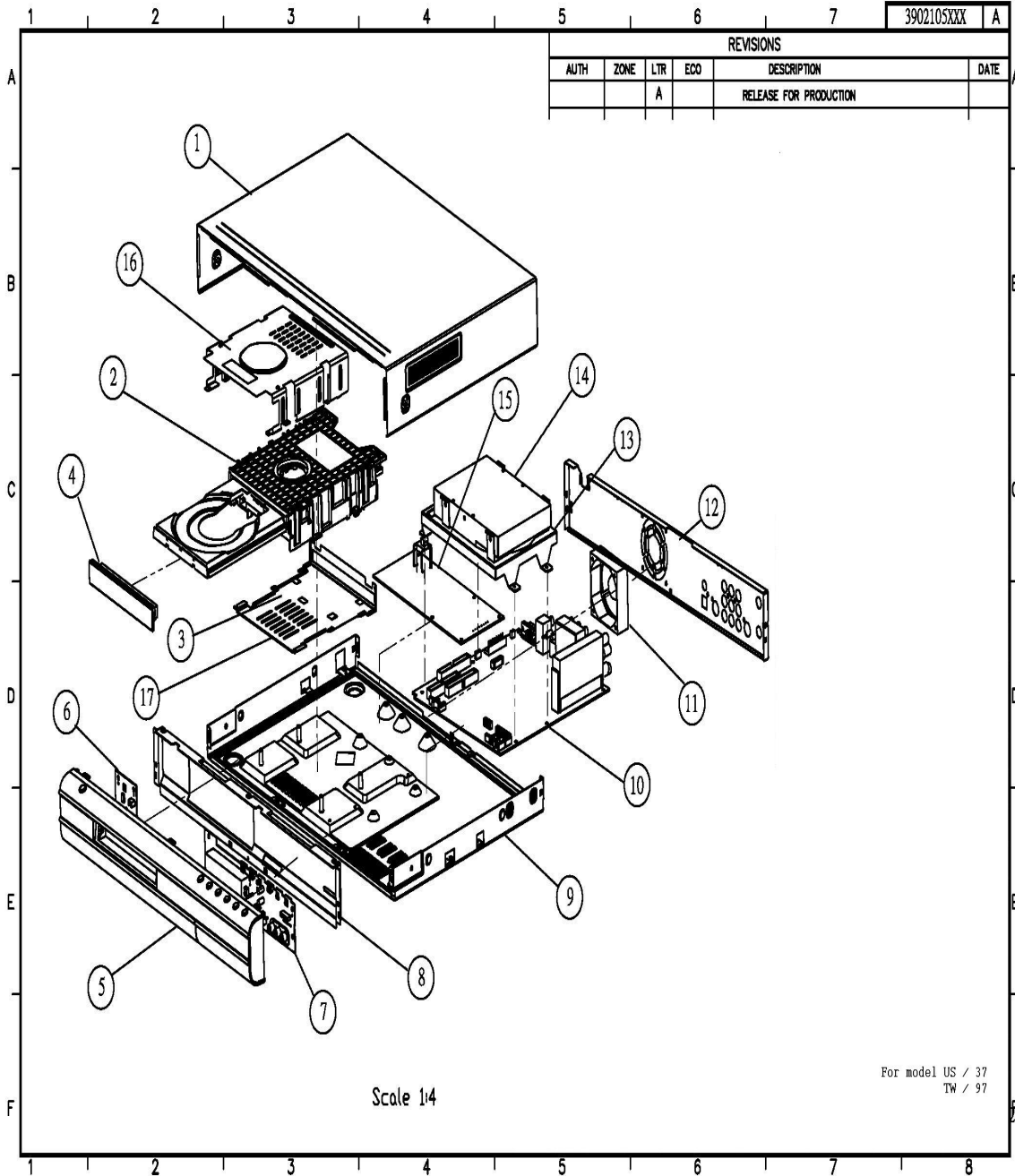



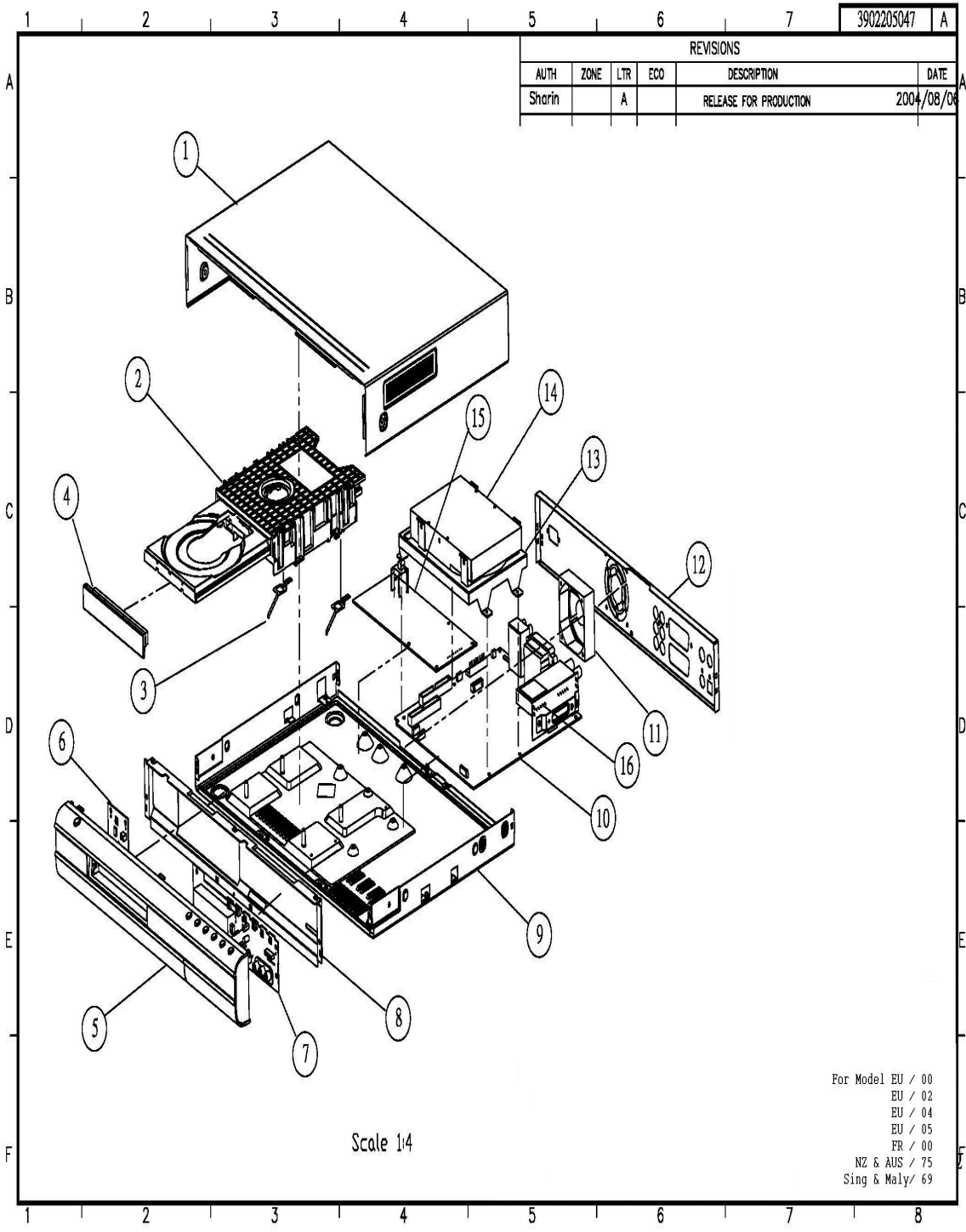

**DVD Test Discs**

7104 099 91851	LVP12.01
7104 099 96851	CD-RW LOW REFLECTION AUDIO DISC
7104 099 94261	RICOH +R (4 SPEED) BLANK DISC

**SERVICE SPARE PARTS**

2	9965 000 27118	DVDR MECHANISM MODULE	except /93
2	9965 000 32519	DVDR MECHANISM MODULE	/93
5+6+7	9965 000 27119	FRONT PANEL + PCBA ASSY	/00/02/04
5+6+7	9965 000 29124	FRONT PANEL + PCBA ASSY	/05
5+6+7	9965 000 29131	FRONT PANEL + PCBA ASSY	/37
5+6+7	9965 000 29051	FRONT PANEL + PCBA ASSY	/69/75
5+6+7	9965 000 29055	FRONT PANEL + PCBA ASSY	/97
5+6+7	9965 000 32520	FRONT PANEL + PCBA ASSY	/93
10	9965 000 27108	MAIN BOARD W/O TUNER	/00/02/05
10	9965 000 29047	MAIN BOARD W/O TUNER	/04
10	9965 000 29052	MAIN BOARD W/O TUNER	/69
10	9965 000 29053	MAIN BOARD W/O TUNER	/75
10	9965 000 29126	MAIN BOARD W/TUNER	/37
10	9965 000 29056	MAIN BOARD W/TUNER	/97
10	9965 000 32521	MAIN BOARD W/TUNER	/93
11	9965 000 27109	FAN	
14	9965 000 26095	HD DRIVE HDD_80G_5400	
15	9965 000 29048	POWER BOARD	/00/02/04/05/69/75
15	9965 000 29130	POWER BOARD	/37
15	9965 000 29057	POWER BOARD	/97
15	9965 000 32522	POWER BOARD	/93
16	9965 000 27117	TUNER UNIT PAL	/00/02/04/05 except France & Germany
16	9965 000 29317	TUNER UNIT PAL	/00 France & Germany
16	9965 000 29050	TUNER UNIT PAL	/69/75
16	9965 000 32518	TUNER UNIT PAL	/93
RC	9965 000 27120	REMOTE CONTROL UNIT	/00/02/04
RC	9965 000 29125	REMOTE CONTROL UNIT	/05
RC	9965 000 29132	REMOTE CONTROL UNIT	/37
RC	9965 000 29049	REMOTE CONTROL UNIT	/69/75
RC	9965 000 29054	REMOTE CONTROL UNIT	/93/97
	9965 000 29318	RCA CABLE	/69/97

Note: Only the parts mentioned in this list are normal service spare parts.

## REVISION LIST

### Version 1.0

- \* Original Release

### Version 1.1

- \* Correction of page 21 - Missing diassembly instruction 7.1

### Version 1.2

- \* Addition of new stroke versions /04, /69, /75 and /97
- \* Removal of unnecessary pages like Introduction, Supplier Test tools
- \* Shifting of exploded view to the end of Manual
- \* Correction & updating of Service parts list

### Version 1.3

- \* Addition of new stroke version /93